

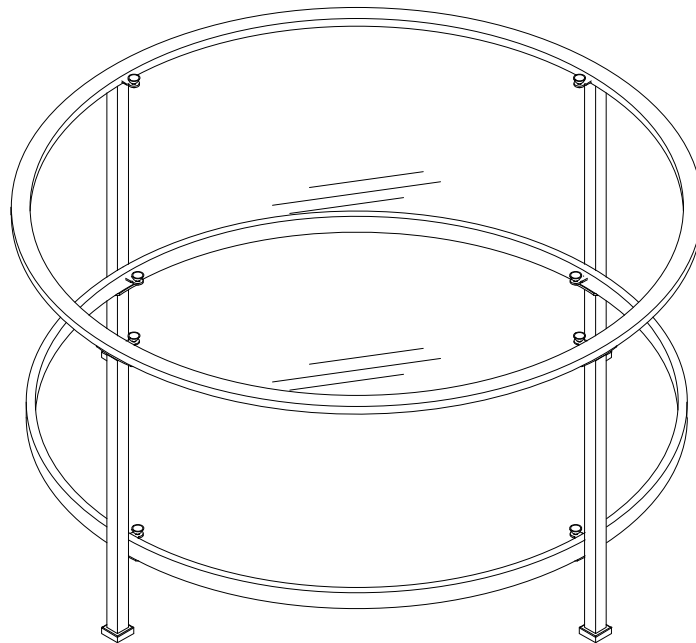

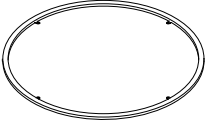

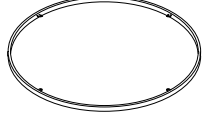

Glass Coffee Table
CF1308

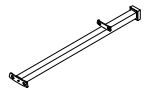

PART LIST

<div data-bbox="108 219 156 264" style="border: 1px solid black; padding: 2px;">A</div> 	<div data-bbox="387 219 435 264" style="border: 1px solid black; padding: 2px;">B</div> 	<div data-bbox="667 219 715 264" style="border: 1px solid black; padding: 2px;">C</div> 	<div data-bbox="946 219 994 264" style="border: 1px solid black; padding: 2px;">D</div> 	<div data-bbox="1225 219 1273 264" style="border: 1px solid black; padding: 2px;">E</div> 
<p style="text-align: center;">Top Frame 1 PC</p>	<p style="text-align: center;">Bottom Frame 1 PC</p>	<p style="text-align: center;">Leg 4 PCS</p>	<p style="text-align: center;">Top Glass 1 PC</p>	<p style="text-align: center;">Bottom Glass 1 PC</p>

HARDWARE LIST

<div data-bbox="108 801 156 846" style="border: 1px solid black; padding: 2px;">#1</div>  <p style="text-align: center;">M6 x 1/2"L</p>	<div data-bbox="387 801 435 846" style="border: 1px solid black; padding: 2px;">#2</div> 
<p style="text-align: center;">Bolt 16 PCS (Extra 2)</p>	<p style="text-align: center;">Allen Wrench 1 PC</p>

Step 1. Carefully lay top frame (part A) upside down on a soft surface, such as carpet, as shown below. Attach legs (part C) to top frame (part A) using bolts (part #1) and allen wrench (part #2).

NOTE: Please do not fully tighten bolts until unit is fully assembled.

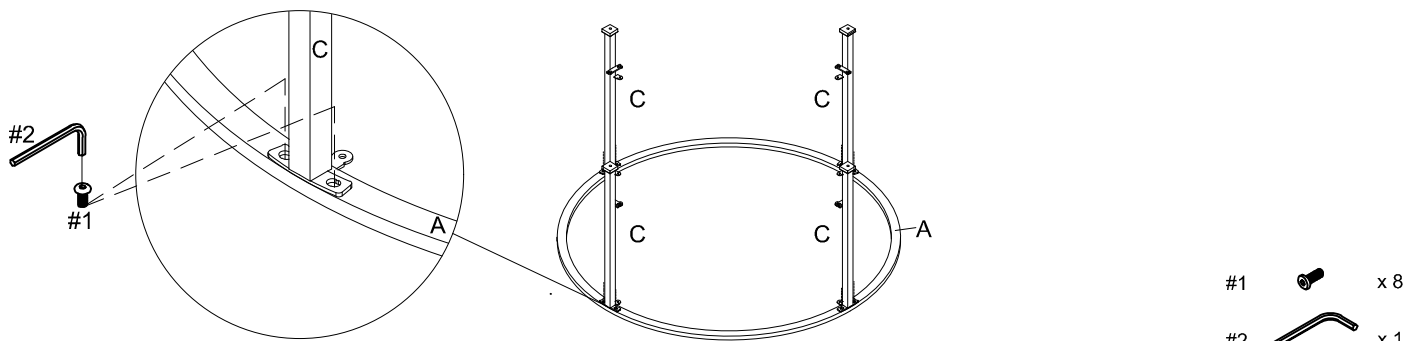

Step 2. Attach bottom frame (part B) to legs (part C) using bolts (part #1) and allen wrench (part #2).

NOTE: Please fully tighten all bolts at this time.

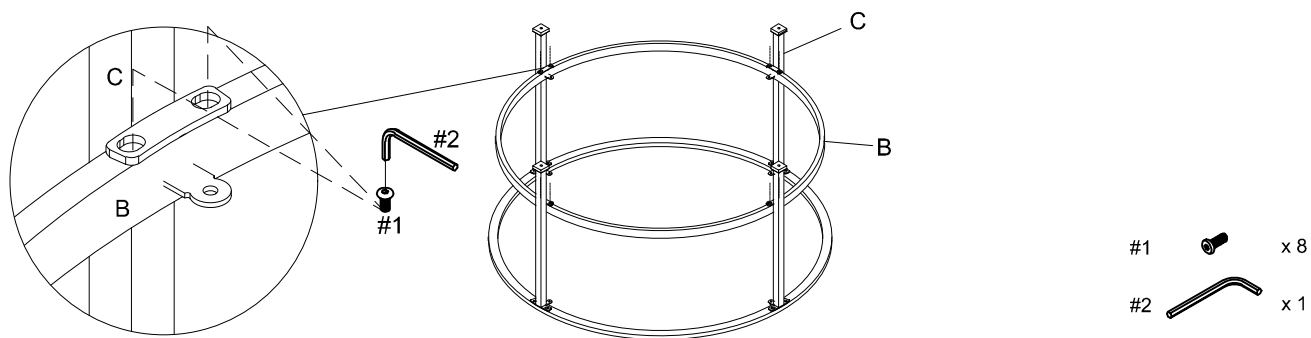

Step 3. Carefully turn unit upright. Install bottom glass (part E) into bottom frame (part B) and top glass (part D) into top frame (part A).

